

Latching Relay G2AK

Magnetic Latching Version of G2A Ideal for Sequence Control

- Double-winding latch system with continuous rating.
- Terminals pulled from the respective junctions between the built-in diodes and set and reset coils allow the built-in diodes to be externally connected for coil surge absorption.
- Excellent vibration/shock resistance with minimal secular decrease in latching power.
- Easy monitoring of ON/OFF operation due to the built-in operation indicator mechanism.
- Same outline dimensions as the standard models of G2A.

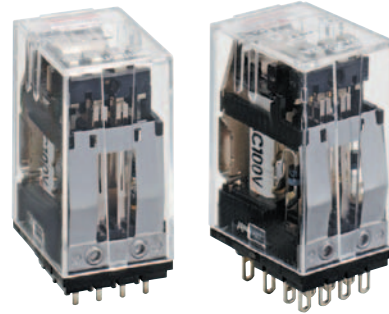

Ordering Information

Contact form	Classification	Plug-in terminals	PCB terminals
DPDT	Standard model	G2AK-232A	G2AK-2321P
	Arc barrier equipped model	G2AK-232AY	---
	Fully sealed model	G2AK-234A	---

Note: 1. When placing your order, add the coil voltage rating to the model number as shown below.
Example: G2AK-232A 100 VAC

Rated coil voltage

- The applicable rated voltage range can be increased by connecting an external resistor. Refer to *Specifications* for details.
- Models meeting UL standards must be specified when ordering. Add "-US" after the model number.

Model Number Legend

G2AK-□□□□□□-□
1 2 3 4 5 6

1. Number of Poles (Contact Form)

2: DPDT

2. Contact Type

3: Crossbar bifurcated

3. Enclosure Construction

2: Casing

4: Fully sealed

4. Terminal Shape

A: Plug-in terminal

1P: PCB terminal

5. Safety Breaking Mechanism

None: No

Y: Arc barrier

6. Approved Standards

None: Standard

US: UL-approved

Arc barrier equipped model	Fully sealed model
The arc barrier equipped model is a relay designed to prevent arc short-circuiting between phases and can be used in a circuit which has potential difference between phases. The switching power of such a circuit with potential difference must be limited to less than 1/2 the rated load when using this Relay.	The fully sealed model is a relay in a gas-tight plastic enclosure and thus exhibits stable performance in an adverse atmosphere of harmful gas, moisture, or powdery dust.

■ Accessories (Order Separately)

Sockets

Item	DIN Track-mounting Socket	Back-connecting Relay			
	Screw terminals	Solder terminals	Wire-wrap terminals	PCB terminals	
Without Hold-down Clip	PYF14A(-E) PYF14A-TU PYF14T	PY14 PY14-3	PY14QN(2)	PY14-0	PY14-02
With Hold-down Clip	---	PY14-Y2	PY14QN-Y2	---	---

Note: See the G2A Datasheet for detailed information on the Relay Hold-down Clips and Socket Mounting Plates.

Specifications

■ Coil Ratings

Rated voltage	Set coil			Reset coil			Set voltage	Reset voltage	Max. voltage	Power consumption	
	Rated current		Coil resistance	Rated current		Coil resistance				Set coil	Reset coil
	50 Hz	60 Hz		50 Hz	60 Hz						
12 VAC	162 mA	158 mA	28 Ω	40 mA	39 mA	125 Ω	80% max. of rated voltage	80% max. of rated voltage	110% of rated voltage	Approx. 1.6 to 2.0 VA	Approx. 0.5 to 1.2 VA
24 VAC	66 mA	64 mA	145 Ω	22.6 mA	22 mA	460 Ω					
50 VAC	34 mA	33 mA	590 Ω	11.3 mA	11 mA	1,900 Ω					
100 VAC	19 mA	18.5 mA	2,150 Ω	12.3 mA	12 mA	3,600 Ω					
6 VDC	360 mA		14 Ω	160 mA		32 Ω				Approx. 2.0 to 2.2 W	Approx. 1.0 to 1.2 W
12 VDC	170 mA		65 Ω	85 mA		125 Ω					
24 VDC	85 mA		270 Ω	50 mA		460 Ω					
48 VDC	44 mA		1,050 Ω	24 mA		1,900 Ω					

- Note:
- The rated current and coil resistance are measured at a coil temperature of 23°C with tolerances of +15%, -20% for AC rated current and ±15% for DC coil resistance.
 - The AC coil resistance values are for reference only.
 - Performance characteristics data are measured at a coil temperature of 23°C.
 - The rated current of the AC operating coil is half-wave rectified current and is measured with a DC ammeter.
 - The peak reverse-breakdown voltage of the built-in diode is 1,000V.
 - The set coil of the Relay rated at 6 VDC is of the 5-minute rating. However, when it is used by connecting a diode in series, it can be of the continuous rating.
 - By connecting an external resistor to each of the set and reset coils as shown in the table below, the rated current of the Relay can be increased.
 - The maximum voltage is one that is applicable instantaneously to the Relay coil at 23°C and not continuously.

Rated voltage	Connected coil voltage	External resistor			
		Set coil		Reset coil	
		Resistance	Capacity	Resistance	Capacity
110 VAC	100 VAC	0.27 kΩ	0.5 W min.	0.39 kΩ	1/4 W min.
200 VAC	100 VAC	2.7 kΩ	5 W min.	8.2 kΩ	3 W min.
220 VAC	100 VAC	3.3 kΩ	6 W min.	9.1 kΩ	3 W min.
100 VDC	48 VDC	1.1 kΩ	10 W min.	2.0 kΩ	6 W min.

Note: Use a resistor having the above resistance value with tolerances of ±10% for external connection.

Method of Connection

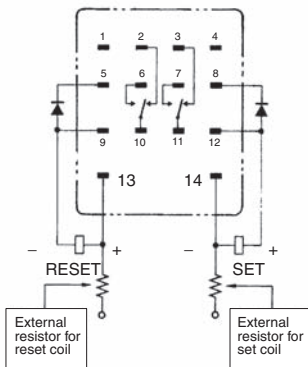

- Reset side
DC coil: Connect terminal No. 13 to terminal No. 9 or No. 13 to No. 5.
AC coil: Connect terminal No. 13 to terminal No. 5.
- Set side
DC coil: Connect terminal No. 14 to terminal No. 12 or No. 14 to No. 8.
AC coil: Connect terminal No. 14 to terminal No. 8.

■ Contact Ratings

Load	Resistive load ($\cos\phi = 1$)	Inductive load ($\cos\phi = 0.4$) (L/R = 7 ms)
Contact type	Crossbar bifurcated	
Contact material	Movable: Au-clad AgPd Fixed: AgPd	
Rated load	0.3 A at 110 VAC 0.5 A at 24 VDC	0.2 A at 110 VAC 0.3 A at 24 VDC
Rated carry current	3 A	
Max. switching voltage	250 VAC, 125 VDC	

■ Characteristics

Contact resistance (see note 2)	100 mΩ max.
Set time (see note 3)	AC: 25 ms max.; DC: 15 ms max.
Reset time (see note 3)	AC: 25 ms max.; DC: 15 ms max.
Min. pulse width	AC: 50 ms; DC: 30 ms
Max. operating frequency	Mechanical: 18,000 operations/hour Electrical: 1,800 operations/hour (under rated load)
Insulation resistance (see note 4)	100 MΩ min. (at 500 VDC)
Dielectric strength	1,500 VAC, 50/60 Hz for 1 minute between coil and contact (700 VAC between contacts of same pole) (1,000 VAC between set and reset coils)
Vibration resistance	Destruction: 10 to 55 to 10 Hz, 0.75 mm single amplitude (1.5 mm double amplitude) Malfunction: 10 to 55 to 10 Hz, 0.5 mm single amplitude (1.0 mm double amplitude) (for contact malfunction); 3.0-mm double amplitude (for armature malfunction)
Shock resistance	Destruction: 1,000 m/s ² Malfunction: 100 m/s ² , 300 m/s ²
Endurance	Mechanical: 100,000,000 operations min. (at operating frequency of 18,000 operations/hour) Electrical: 5,000,000 operations min. (under rated load and at operating frequency of 1,800 operations/hour) (see note 5)
Error rate (level P) (Reference value) (see note 6)	1 mA at 100 mVDC
Ambient temperature	Operating: -10°C to 40°C (with no icing or condensation)
Ambient humidity	Operating: 5% to 85%
Weight	Approx. 38 g

- Note:**
- The data shown above are initial values.
 - The contact resistance was measured with 0.1 A at 5 VDC using the fall-of-potential method.
 - The set or reset time was measured with the rated voltage imposed with any contact bounce ignored at an ambient temperature of 23°C.
 - The insulation resistance was measured with a 500-VDC megger applied to the same places as those used for checking the dielectric strength.
 - The electrical endurance was measured at an ambient temperature of 23°C.
 - This value was measured at a switching frequency of 60 operations per minute.

Approved by Standards

UL (File No. E41515)

Model	Coil ratings	Contact ratings
G2AK-□	6 to 100 VAC 6 to 50 VDC	1 A 120 VAC (resistive load) 1 A 30 VDC (inductive load)

Engineering Data

Maximum Switching Power

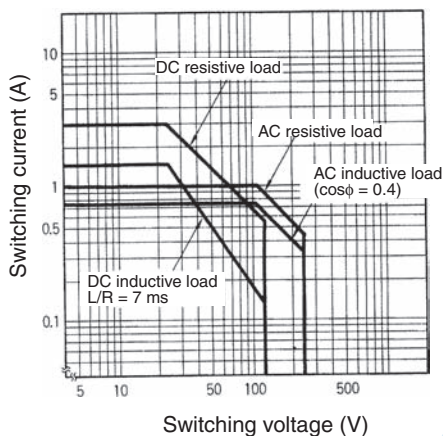

Endurance

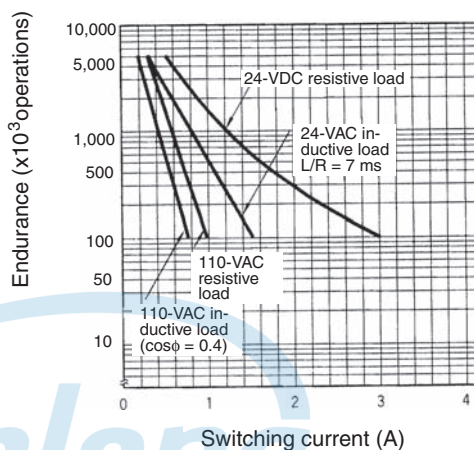

Malfunctioning Shock

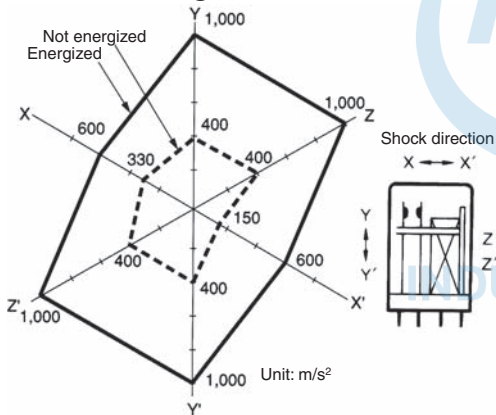

Number of samples = 5
Measurement conditions: Impose a shock of 100 m/s² in the ±X, ±Y, and ±Z directions three times each with the Relay energized and not energized to check the shock values that cause the Relay to malfunction.

Changes in Operating Characteristics vs. External Magnetic Field

G2AK-232A 24 VDC (Mean Value)

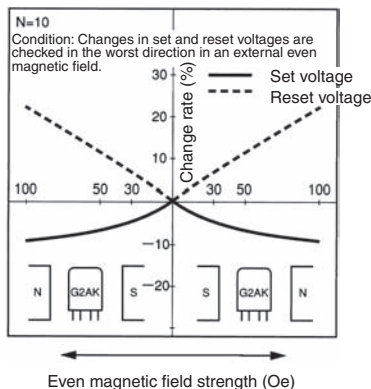

(Mean Value)

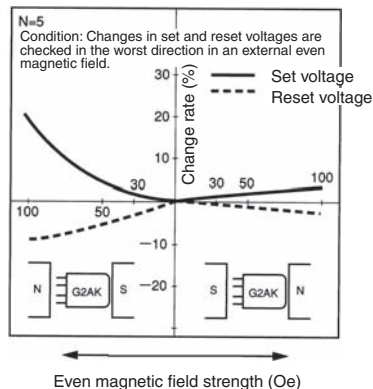

Hold Force Attenuation vs. Elapsed Time

G2AK-232A 24 VDC

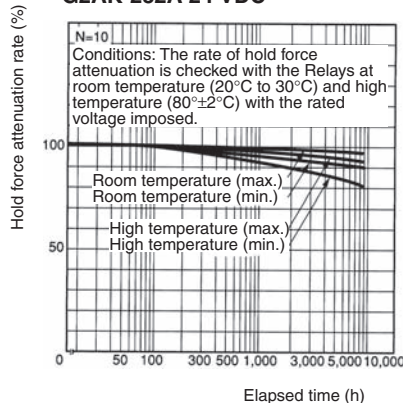

Dimensions

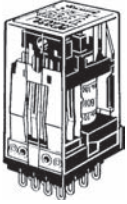

G2AK-232

Arc Barrier Equipped Models with Plug-in Terminals G2AK-232A(Y)

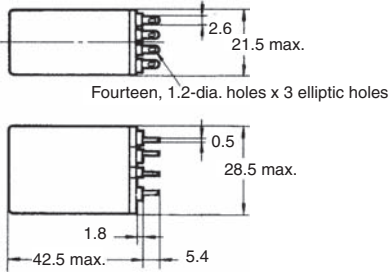

with PCB Terminals G2AK-2321P(Y)

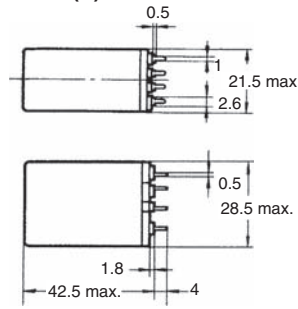

Fully Sealed Models with Plug-in Terminals G2AK-234A

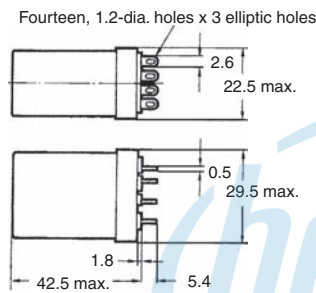

with PCB Terminals G2AK-2341P

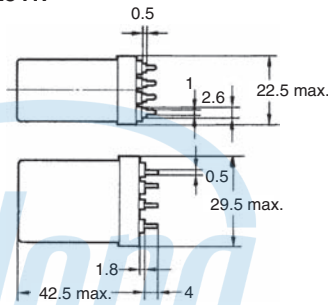

Mounting Holes on PCB (Bottom View)

Note: Dimensional tolerances are ± 0.1 mm

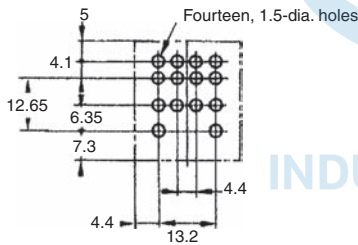

Terminal Arrangement/Internal Connections (Bottom View)

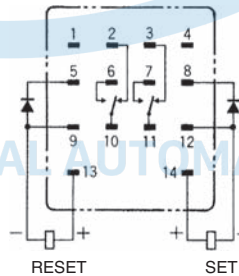

Note: Terminals (Nos. 12 and 9) are pulled from the respective junctions between the diode and set coil and between the diode and reset coil. Use these terminals through external connection for selective use or non-use of the diodes as well as for surge prevention.

Safety Precautions

Refer to *Safety Precautions for All Relays*.

The G2AK can be used for special purposes by utilizing its built-in diodes.

When built-in diodes are not required

- With the DC-coil Latching Relay, the built-in diodes become unnecessary for a circuit in which a coil operating switch is incorporated for each of the set and reset coils as shown on the right.
- With the DC/AC-coil Latching Relay, if the junctions between the set coil and built-in diode and between the reset coil and built-in diode are connected as shown on the right, only one of the built-in diode is required and the rest of the diodes become unnecessary. However, a coil operating switch is required for each coil. In this case, because of the diode characteristics, the load rating must be 0.5 A or less.

When built-in diodes are required

- When using the AC-coil Latching Relay which operates on commercial AC input, the built-in diodes are required.
- With the DC/AC-coil Latching Relay, the built-in diodes are required for an inductive electrical equipment circuit which consists of two or more set/reset coils, motor M, general electromagnetic coil X, etc. per coil operating switch as shown on the right.

Examples of built-in diode applied circuit

- With the DC-coil Latching Relay, the built-in diode(s) can be used for surge absorption. In this case, pay attention to the polarity of the coil. Note that the 5-minute rating applies only to the set coil rated at 6 VDC and the continuous rating for other DC coil voltages remains unchanged.

- With the AC-coil Latching Relay, a half-wave rectified power supply can be obtained as shown on the right. This can be used as a power supply for light-emitting diodes. However, because of the diode characteristics, the load rating must be 0.5 A or less.

Note: If a smoothing capacitor is used as shown on the right, the waveform of the current that flows into the set or reset coil changes from half wave to that of nearly direct current. In other words, ripple is improved but the coil temperature rises, which may adversely affect the set or reset voltage. Therefore, avoid circuit configuration with an electronic device which improves ripple, such as a capacitor.

Circuits

Do not allow voltage to be applied simultaneously to both the set and reset coil. If voltage is applied simultaneously, the operation will become unstable.

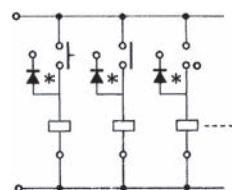

* Unwanted diodes

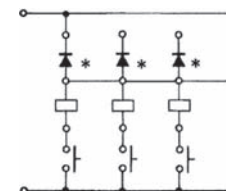

* Unwanted diodes

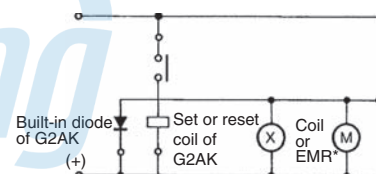
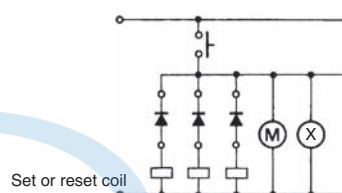

5 (8) 13 (14)

* EMR: General-purpose electromagnetic relay

The figures above represent the terminal numbers. The figures in parentheses represent the terminals on the set side.

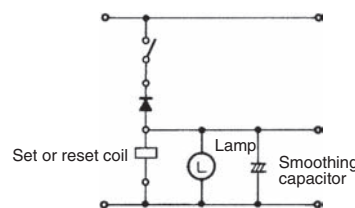
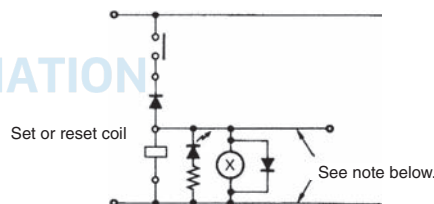

ALL DIMENSIONS SHOWN ARE IN MILLIMETERS.
To convert millimeters into inches, multiply by 0.03937. To convert grams into ounces, multiply by 0.03527.

In the interest of product improvement, specifications are subject to change without notice.