

## GF Series

### Digital counter / Timer

- Counter & timer
- Pre-scale setting (GF7)
- Input action 14 kinds, output action 16 kinds
- Set up the digit of decimal points
- Timer range 16 kinds  
(10/60 decimal system each 8 kinds)
- NPN/PNP (voltage / non-voltage) input selectable



C

Counter /  
Timer

### Suffix code

| Model              | Code  | Description                                   |
|--------------------|---|---|
| GF7 -              | <input type="checkbox"/> <input type="checkbox"/> <input type="checkbox"/> <input type="checkbox"/> | Digital counter / Timer (72 X 72 mm)          |
| Type               | P   | Pre-set counter                               |
|                    | T   | Total counter                                 |
| Displayable digits | 4   | 4 digits (9999)                               |
|                    | 6   | 6 digits (999999)                             |
| Setting stage      | 1   | 1 <sup>st</sup> stage setting                 |
|                    | 2   | 2 <sup>nd</sup> stage setting                 |
|                    | 0   | Total counter                                 |
| Pre-scale function | E   | Pre-scale function built in (Pre-set counter) |
|                    | N   | No pre-scale (Total counter)                  |

| Model              | Code  | Description                                     |
|--------------------|---|---|
| GF4 -              | <input type="checkbox"/> <input type="checkbox"/> <input type="checkbox"/> <input type="checkbox"/> | Digital counter / Timer (48 X 48 mm)            |
| Type               | P   | Pre-set counter                                 |
|                    | T   | Total counter                                   |
| Displayable digits | 4   | 4 digits (9999)                                 |
| Setting stage      | 1   | 1 <sup>st</sup> stage setting (Pre-set counter) |
|                    | 0   | None (total counter)                            |
| Terminal structure | N   | Terminal  |
|                    | S   | 8 pin structure (suitable for 8 pin socket)     |

## Specification

### Input

| Model                   | GF4  | GF7  |
|-------------------------|--|--|
| Input computation speed | 30 cps, 5K cps<br>(select by using the deep switch)  | 30 cps, 1K, 3K, 5K cps , select by using the volume (located on the front panel) |
|                         | ON/OFF ratio: when ratio is 1:1  |  |
| Input signal type       | PNP input (voltage input) or NPN input (non-voltage input)<br>Signal stage : "H" 5 – 30 V DC "L" 0 – 2 V DC                |  |
| Inhibit input           | Computation stops when signal is ON (20 ms min)  |  |
| Reset                   | Power reset (for more than 0.5 s), external reset (for more than 20 ms), auto reset  |  |
| Noise immunity          | Square wave noise due to the noise simulator (1 $\mu$ s pulse width),<br>$\pm 2$ kV (between the operation power terminal) |  |

### Function

|                       |  |   |
|-----------------------|--|---|
| Timer                 | setting error  | Less than $\pm 0.01\%$ $\pm 0.05$ sec (only with the power START)   |
|                       | Repeating operation error  | Less than $\pm 0.005\%$ $\pm 0.003$ sec (only with the reset START) |
| Insulation resistance | 100 M $\Omega$ min (500 V DC mega electric conduction terminal–non recharging metal) |   |
| Dielectric strength   | 2000 V AC 60 Hz for 1 min (different charging terminal from each other)              |   |

### Function and output

| Model                              | GF4-P41N   | GF4-T40N | GF7-P□□E   | GF7-T60N          |
|------------------------------------|--|----------|--|-------------------|
| Counter/timer selection            | Counter operation and timer operation selectable   |          |  |                   |
| Input action                       | Up, down, and up/down selectable (refer to the input operation mode)   |          |  |                   |
| Output action (counter)            | F, N, C, R, K, P, Q, S, A selectable (refer to the output action mode)<br>※ With the total counter, it is displayed as F, K output mode                            |          |  |                   |
| Output type                        | ON delay and OFF delay selectable by the deep switch   |          |  |                   |
| OUT1 function selectable           | Hold, One-shot, Flickering (1 sec gap) function selectable (applicable only with 2 stages setting type)  |          |  |                   |
| Pre-scale                          | Applicable only with free-set counter , 0.001 ~ 9999(4digits), 0.00001 ~ 999999(6digits)   |          |  |                   |
| Recognizing computed value setting | Recognize at all times (possible to change the setting in the middle of applying electric current)   |          |  |                   |
| Power backup selectable            | Power failure compensation/Power reset selectable, semi-permanent when<br>Selecting power failure compensation (use EEPROM)  |          |  |                   |
| Displayable digits                 | 4 digits (9999)  |          | 4 digits / 6 digits                                  | 6 digits (999999) |
| decimal points display             | 4 digits : 888.8 / 8888, 6 digits : 888888 / 88888.8 / 8888.88 / 888.888   |          |  |                   |
| Setting stage                      | 1 <sup>st</sup> stage  | None     | 1 <sup>st</sup> stage / 2 <sup>nd</sup> stage        | None              |
| ONE SHOT output                    | 0.1 ~ 12.5 sec (set by the front TM volume)  |          | 0.05 sec – 5.8 sec (set by the front TM volume)      |                   |
| External power supply              | 12 V DC 100 mA max.  |          | 12 V DC 100 mA max.                                  |                   |
| Character display                  | height : 8 mm  |          | height : 11 mm (4 digits), height : 10 mm (6 digits) |                   |
| Output                             | Relay 1 <sup>st</sup> / 2 <sup>nd</sup> : 1c, 250 V AC, 3 A (resistive load)<br>(only 2 <sup>nd</sup> output is valid for the 1 <sup>st</sup> stage output)        |          |  |                   |
|                                    | Transistor 1 <sup>st</sup> / 2 <sup>nd</sup> : open collector, 30 V DC, 100 mA max.<br>(only 2 <sup>nd</sup> output is valid for the 1 <sup>st</sup> stage output) |          |  |                   |

C

Counter /  
Timer

### Standard specification

| Model                | GF4-P   | GF4-T         | GF7-P  | GF7-T         |
|----------------------|---|---------------|--|---------------|
| Power supply voltage | 100 – 240 V AC 50 – 60 Hz                                     |               |  |               |
| Voltage fluctuation  | ±10 % of the power supply voltage                             |               |  |               |
| Power consumption    | Approx 6.2 VA   | Approx 4.3 VA | GF7-P61 : Approx 7.6 VA<br>GF7-P62 : Approx 8.7 VA | Approx 6.4 VA |
| Ambient temperature  | -10 ~ 55 °C   |               |  |               |
| Ambient humidity     | 35 ~ 85 % RH  |               |  |               |
| Storage temperature  | -20 ~ 65 °C   |               |  |               |
| Vibration resistance | 10 – 55 Hz, peak amplitude 0.75 mm, 3 axis each direction, 1h |               |  |               |
| Shock resistance     | 300 %, 3 times each in 3 axes each direction                  |               |  |               |
| Weight               | 184 g   | 168 g         | 243 g  | 208 g         |

### Name of each part

#### GF4

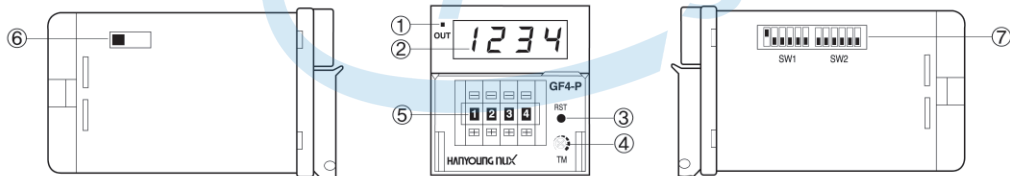

| Number | Name                             | Description   |
|--------|----------------------------------|---|
| ①      | Output action LED                | Light ON when control output is ON  |
| ②      | Computation/Time displaying unit | Display the computed value in counter action, display the action time in timer action   |
| ③      | Reset key                        | Reset the computed value of counter or operation time of counter,<br>Applied when changing the counter and timer action specification |
| ④      | TM volume                        | Set the operation time of control output by the One-short time (setting range: 0.1s~12.5s)  |
| ⑤      | Digital switch                   | Set the computed value of counter or operation time of timer  |
| ⑥      | PNP/NPN input switch             | PNP/NPN input selectable by the deep switch   |
| ⑦      | Function setting (SW1)           | DOWN/UP, power backup memory/power reset, input mode (timer range), timer/counter   |
|        | Function setting(SW2)            | Computation speed, decimal points, ON-DELAY / OFF-DELAY, output mode selectable   |

GF7

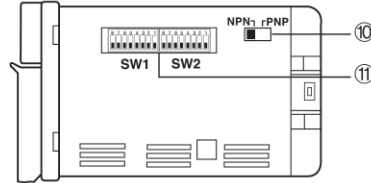
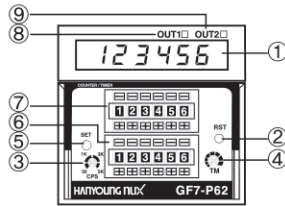

| Number | Name   | Description  |
|--------|--|--|
| ①      | Computation/time displaying unit               | Display the computed value in counter action, display the action time in timer action  |
| ②      | Reset key                                      | Initialize the computed value or timer operation time of counter, Applied when changing the counter and timer action specification |
| ③      | CPS(Computation speed setting volume)          | Counter computing speed selectable (30 cps, 1 Kcps, 3 Kcps, 5 Kcps)  |
| ④      | TM volume                                      | Set the operation time of control output by the One-short time (setting range: 0.1s~12.5s)   |
| ⑤      | SET key  | Used when setting the free-scale   |
| ⑥      | 2 <sup>nd</sup> stage set value setting switch | 2 <sup>nd</sup> stage computation set value setting switch (time setting in case of timer)   |
| ⑦      | 1 <sup>st</sup> stage set value setting switch | 1 <sup>st</sup> stage computation set value setting switch (time setting in case of timer)   |
| ⑧      | 1 <sup>st</sup> stage output display LED       | Light ON with 1 <sup>st</sup> stage output action  |
| ⑨      | 2 <sup>nd</sup> stage output display LED       | Light ON with 2 <sup>nd</sup> stage output action  |
| ⑩      | PNP/NPN input switch                           | PNP/NPN input selectable by the deep switch  |
| ⑪      | Function setting (SW1)                         | OFF-DELAY/ON-DELAY, DOWN/UP, power backup memory/power reset, input mode (timer range), timer/counter, pre-scale selectable        |
|        | Function setting (SW2)                         | 1 <sup>st</sup> stage output mode setting (Hold, Flicking, One-shot)<br>2 <sup>nd</sup> output mode setting, decimal point setting |

Cautious) operate as 2<sup>nd</sup> stage setting with 1<sup>st</sup> stage setting type

C

Counter /  
Timer

### Function setting

#### GF4

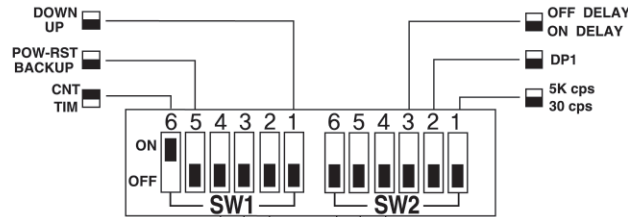

| TIM     | CNT     | 4                        | 3                        | 2                        | 6                        | 5                        | 4                        | TIM | CNT |
|---------|---------|--------------------------|--------------------------|--------------------------|--------------------------|--------------------------|--------------------------|-----|-----|
| 99.99s  | U-A (R) | <input type="checkbox"/> | <input type="checkbox"/> | <input type="checkbox"/> | <input type="checkbox"/> | <input type="checkbox"/> | <input type="checkbox"/> | F   | F   |
| 999.9s  | U-A (F) | <input type="checkbox"/> | <input type="checkbox"/> | <input type="checkbox"/> | <input type="checkbox"/> | <input type="checkbox"/> | <input type="checkbox"/> | N   | N   |
| 9999s   | U-B (F) | <input type="checkbox"/> | <input type="checkbox"/> | <input type="checkbox"/> | <input type="checkbox"/> | <input type="checkbox"/> | <input type="checkbox"/> | C   | C   |
| 99m 59s | U-B (R) | <input type="checkbox"/> | <input type="checkbox"/> | <input type="checkbox"/> | <input type="checkbox"/> | <input type="checkbox"/> | <input type="checkbox"/> | R   | R   |
| 999.9m  | Ud - A  | <input type="checkbox"/> | <input type="checkbox"/> | <input type="checkbox"/> | <input type="checkbox"/> | <input type="checkbox"/> | <input type="checkbox"/> | K   | K   |
| 99h 59m | Ud - B  | <input type="checkbox"/> | <input type="checkbox"/> | <input type="checkbox"/> | <input type="checkbox"/> | <input type="checkbox"/> | <input type="checkbox"/> | P   | P   |
| 999.9h  | Ud - C  | <input type="checkbox"/> | <input type="checkbox"/> | <input type="checkbox"/> | <input type="checkbox"/> | <input type="checkbox"/> | <input type="checkbox"/> | Q   | Q   |
| 9999h   | Ud - C  | <input type="checkbox"/> | <input type="checkbox"/> | <input type="checkbox"/> | <input type="checkbox"/> | <input type="checkbox"/> | <input type="checkbox"/> | A   | S   |

| Switch classification | Name | Description   |
|-----------------------|------|---|
| SW1                   | 1    | DOWN/UP<br>ON : DOWN<br>OFF : UP  |
|                       | 2    | Counter input mode (timer range)<br>Select the input mode of counter or time range of timer by ON/OFF the switch number 2, 3 and 4.<br>※ Input mode in the GF4 8 pin type is limited into 2 types (UP A(R) and UP A(F)) (1 computed input signal) |
|                       | 3    |   |
|                       | 4    |   |
|                       | 5    | POW-RST/BACK-UP<br>ON : Power reset (POW-RST)<br>OFF : Power backup memory (BACK UP)  |
|                       | 6    | CNT/TIM<br>ON : Counter (CNT)<br>OFF : Timer (TIM)  |
| SW2                   | 1    | 30 cps / 5 K cps<br>ON : 5 K cps<br>OFF : 30 cps counter computing speed selectable   |
|                       | 2    | Decimal point selectable<br>ON : 888.8<br>OFF : 8888  |
|                       | 3    | OFF-DELAY/ON-DELAY<br>ON : OFF-DELAY<br>OFF : ON-DELAY  |
|                       | 4    | Output mode selectable<br>Select the output mode by ON/OFF the switch number 4, 5 and 6 SW2 (UP/DOWN each 8 kinds)  |
|                       | 5    |   |
|                       | 6    |   |

GF7

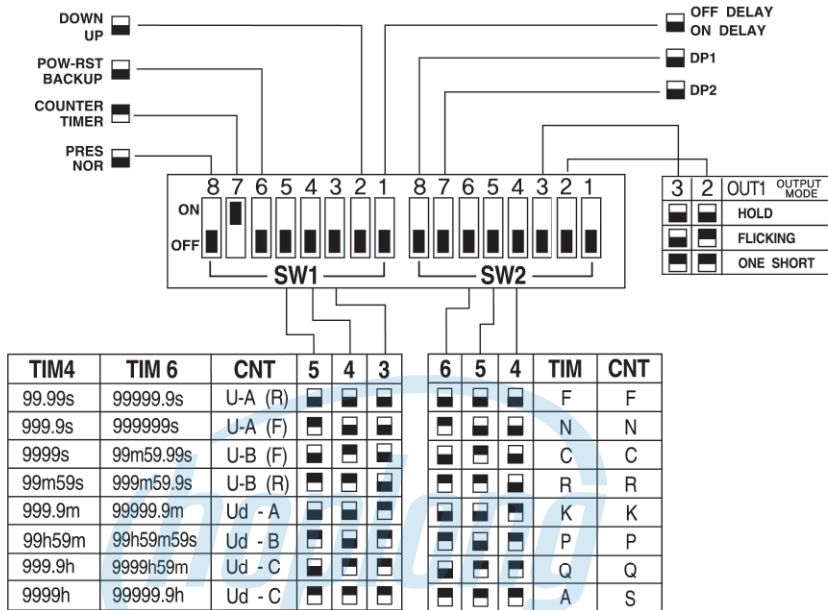

| Switch classification | Name | Description  |
|-----------------------|------|--|
| SW1                   | 1    | OFF-DELAY/<br>ON-DELAY<br>ON : OFF-DELAY<br>OFF : ON-DELAY   |
|                       | 2    | DOWN/UP<br>ON : DOWN<br>OFF : UP   |
|                       | 3    | Counter input mode<br>(timer range)<br>Select the input mode of counter or time range of timer by<br>ON/OFF the switch number 2, 3 and 4. SW1  |
|                       | 4    |  |
|                       | 5    |  |
|                       | 6    | POW-RST/<br>BACK-UP<br>ON : Power reset (POW-RST)<br>OFF : Power backup memory (BACK UP)   |
|                       | 7    | CNT/TIM<br>ON : Counter (CNT)<br>OFF : Timer (TIM)   |
|                       | 8    | PRES/NOR<br>ON : PRES (Free-scale setting mode selectable)<br>OFF : NOR (Free-scale mode lock selectable)  |
| SW2                   | 1    | -<br>None  |
|                       | 2    | 1 <sup>st</sup> stage (OUT1)   |
|                       | 3    | output mode setting<br>1 <sup>st</sup> stage (OUT1) output mode setting within 2 <sup>nd</sup> stage setting type timer function<br>※ Hold, Flicking (ON : 0.5sec, OFF : 0.5sec), One-shot (0.5sec fixation) |
|                       | 4    | output mode<br>selectable<br>2 <sup>nd</sup> stage output mode with the 2nd stage setting type counter<br>1 <sup>st</sup> output mode setting with the 1st setting type counter                              |
|                       | 5    |  |
|                       | 6    |  |
|                       | 7    | Decimal point digits setting<br>Position of decimal point setting by the switch composition (0~3 digits setting)   |
|                       | 8    |  |

# C

Counter /  
Timer

### ● Timer function

|  |   |
|--|---|
| Selecting the timer function                     | Select the function by using the deep switch  |
| Inhibit input                                    | Processing time stops when signal is ON (20 ms min)   |
| Changing decimal system                          | Select 10 decimal system or sexagesimal system for the time displaying type   |
| Time range                                       | Select the time range and UP/DOWN indication by the deep switch (8 kinds)   |
| Output action                                    | F, N, C, R, K, P, Q, A (selection done by the deep switch)  |
| Total timer indication                           | Indicated as the F, K output action mode  |
| Output type                                      | Select ON-Delay/OFF-Delay by the deep switch  |
| Indication when reset                            | Up-0, Down-set value  |
| 1 <sup>st</sup> stage (OUT1) output mode setting | 1 <sup>st</sup> stage (OUT1) output mode setting within 2 <sup>nd</sup> stage setting type timer(GF7) function<br>* Hold, Flicking (ON : 0.5sec, OFF : 0.5sec), One-shot (0.5sec fixed) |

### ● Timer range selection

GF4

| SW1    | UP mode   | SW1    | DOWN mode |
|--------|-----------|--------|-----------|
| ON OFF | 99.99 s   | ON OFF | 99.99 s   |
| ON OFF | 999.9 s   | ON OFF | 999.9 s   |
| ON OFF | 9999 s    | ON OFF | 9999 s    |
| ON OFF | 99 m 59 s | ON OFF | 99 m 59 s |
| ON OFF | 999.9 m   | ON OFF | 999.9 m   |
| ON OFF | 99 h 59 m | ON OFF | 99 h 59 m |
| ON OFF | 999.9 h   | ON OFF | 999.9 h   |
| ON OFF | 9999 h    | ON OFF | 9999 h    |

















(Cautious)

0 is displayed when Reset signal is inputted in the UP mode

Set value is displayed when Reset signal is inputted in the DOWN mode

Time range of GF4 socket type is same as GF4 terminal type

GF7

| SW1  | UP mode             |                     | SW1  | DOWN mode           |                     |
|--|---------------------|---------------------|--|---------------------|---------------------|
|  | 4 digits time range | 6 digits time range |  | 4 digits time range | 6 digits time range |
| ON OFF  | 99.99 s             | 99999.9 s           | ON OFF  | 99.99 s             | 99999.9 s           |
| ON OFF  | 999.9 s             | 999999 s            | ON OFF  | 999.9 s             | 999999 s            |
| ON OFF  | 9999 s              | 99 m 59.99 s        | ON OFF  | 9999 s              | 99 m 59.99 s        |
| ON OFF  | 99 m 59 s           | 999 m 59.9 s        | ON OFF  | 99 m 59 s           | 999 m 59.9 s        |
| ON OFF  | 999.9 m             | 99999.9 m           | ON OFF  | 999.9 m             | 99999.9 m           |
| ON OFF  | 99 h 59 m           | 99 h 59 m 59 s      | ON OFF  | 99 h 59 m           | 99 h 59 m 59 s      |
| ON OFF  | 999.9 h             | 9999 h 59 m         | ON OFF  | 999.9 h             | 9999 h 59 m         |
| ON OFF  | 9999 h              | 99999.9 h           | ON OFF  | 9999 h              | 99999.9 h           |

(Cautious)

0 is displayed when Reset signal is inputted in the UP mode

Set value is displayed when Reset signal is inputted in the DOWN mode

INDUSTRIAL AUTOMATION

C  
Counter /  
Timer



● Counter input action

GF4

■ GF4-P41N / GF4-T40N

Caution) 'A' requires at least the min signal width and 'B' requires at least the half of min signal width.

Caution) The following input logic of counter input mode is for the 'PNP' mode.

Caution) When input logic is set as the 'NPN' mode, please use it as reverse of the 'PNP' mode.

• Rising state of the Input signal (  $\uparrow$  )

• Falling state of the Input signal (  $\downarrow$  )

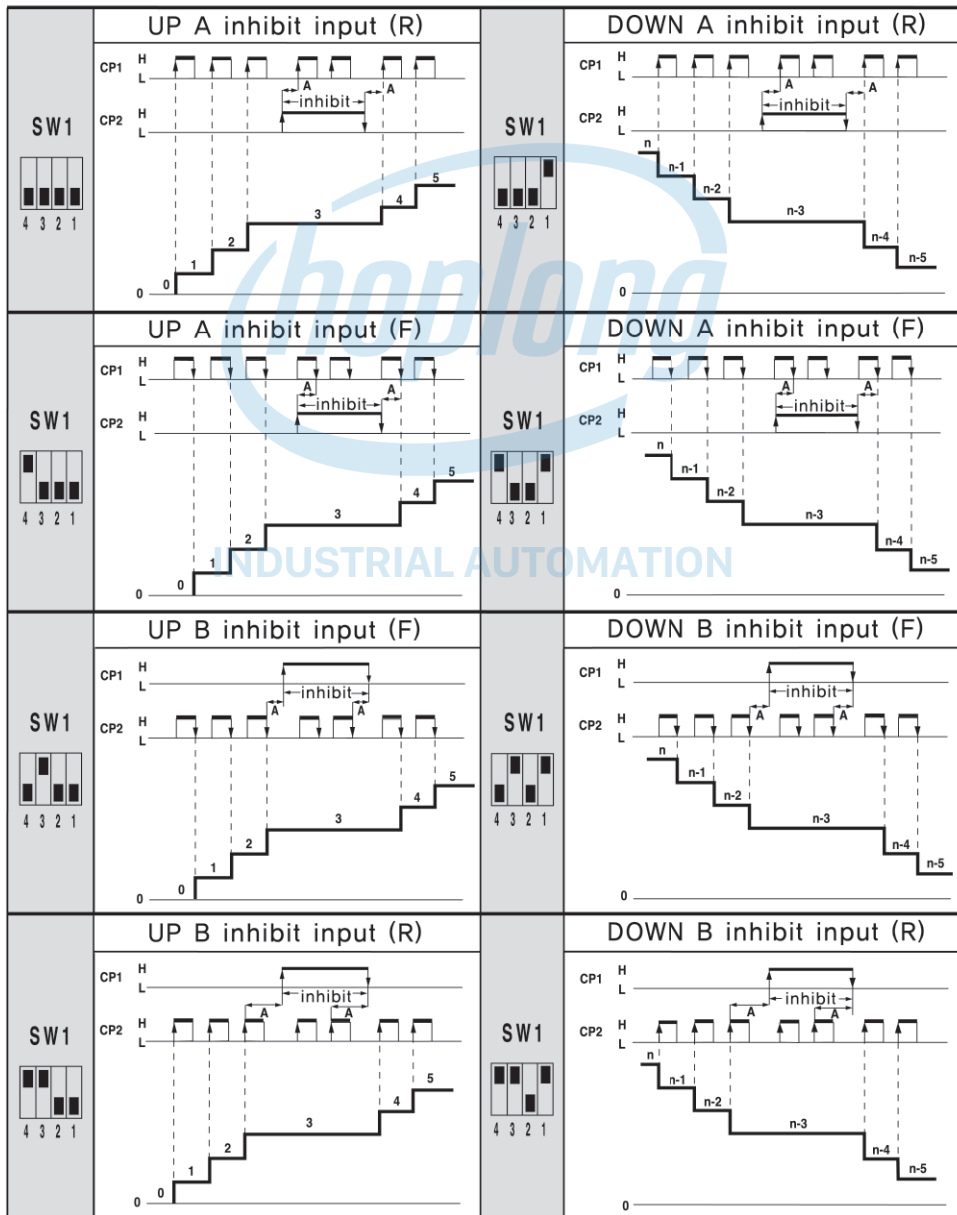

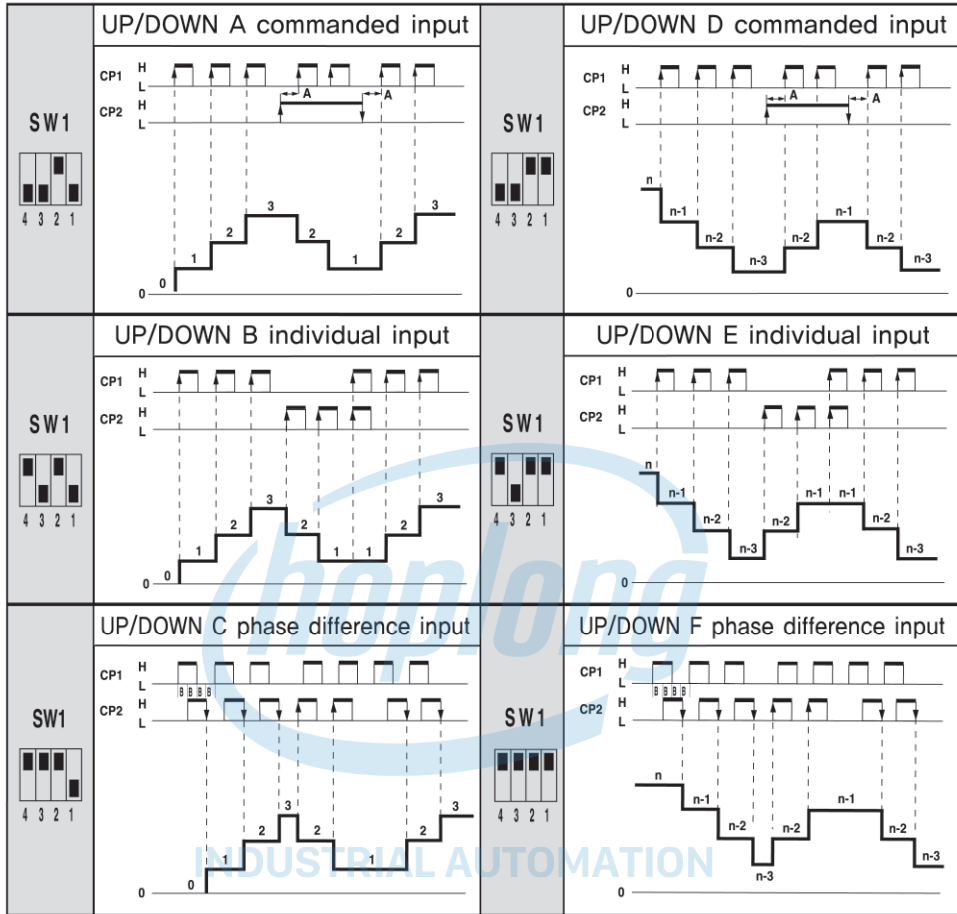

C  
Counter /  
Timer

■ GF4-P41S

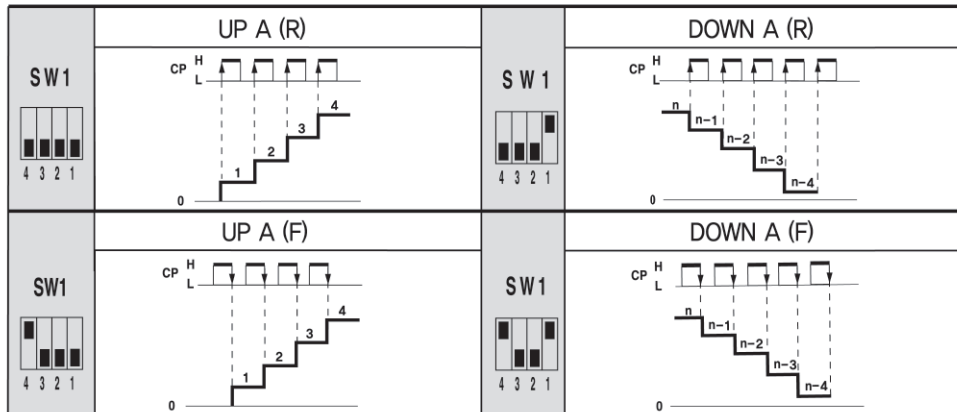

● Counter input action

GF7

Caution) 'A' requires at least the min signal width and 'B' requires at least the half of min signal width.

Caution) The following input logic of counter input mode is for the 'PNP' mode.

Caution) When input log is set as the 'NPN' mode, please use it as reverse of the 'PNP' mode.

• Rising state of the Input signal (  $\uparrow$  )

• Falling state of the Input signal (  $\downarrow$  )

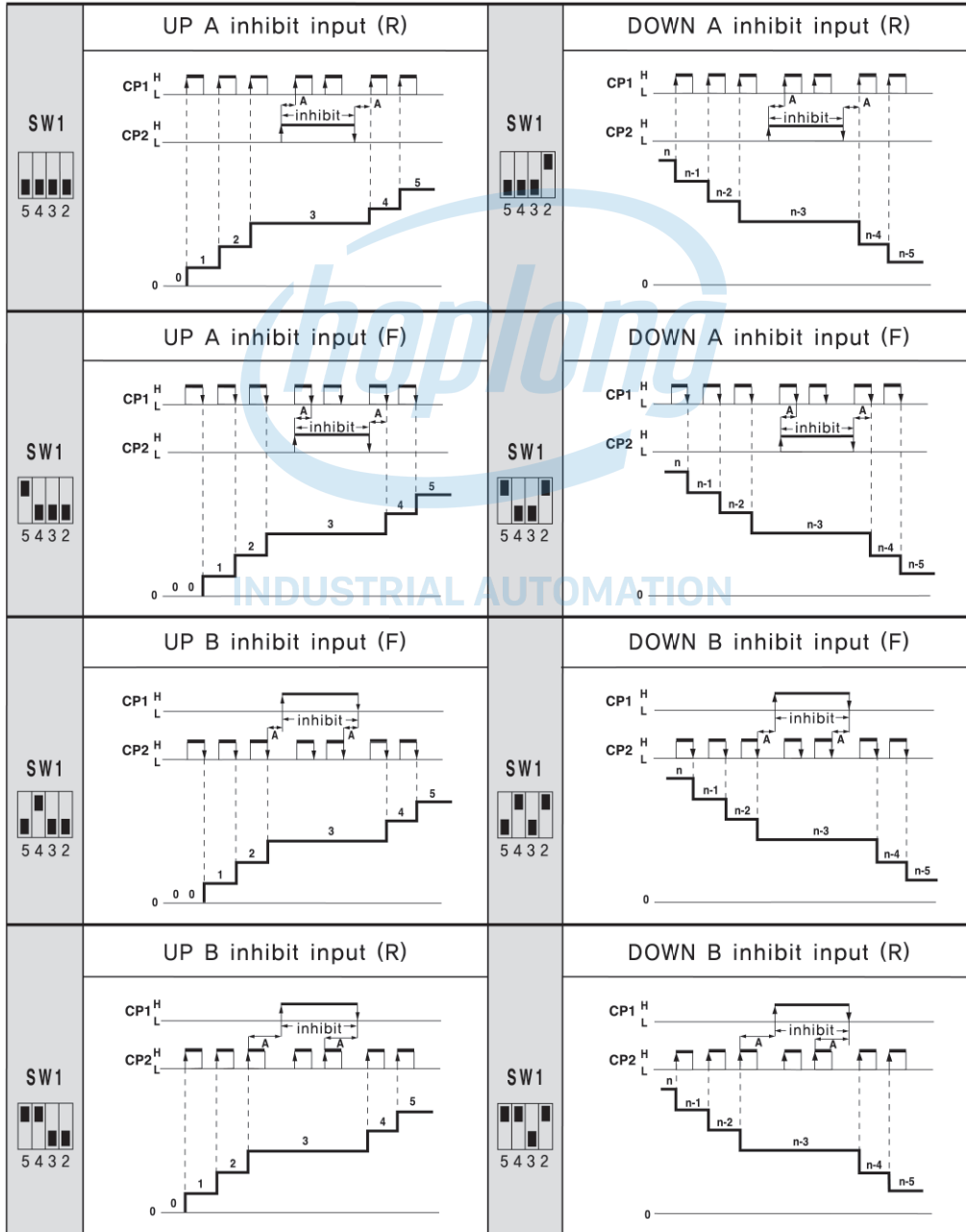

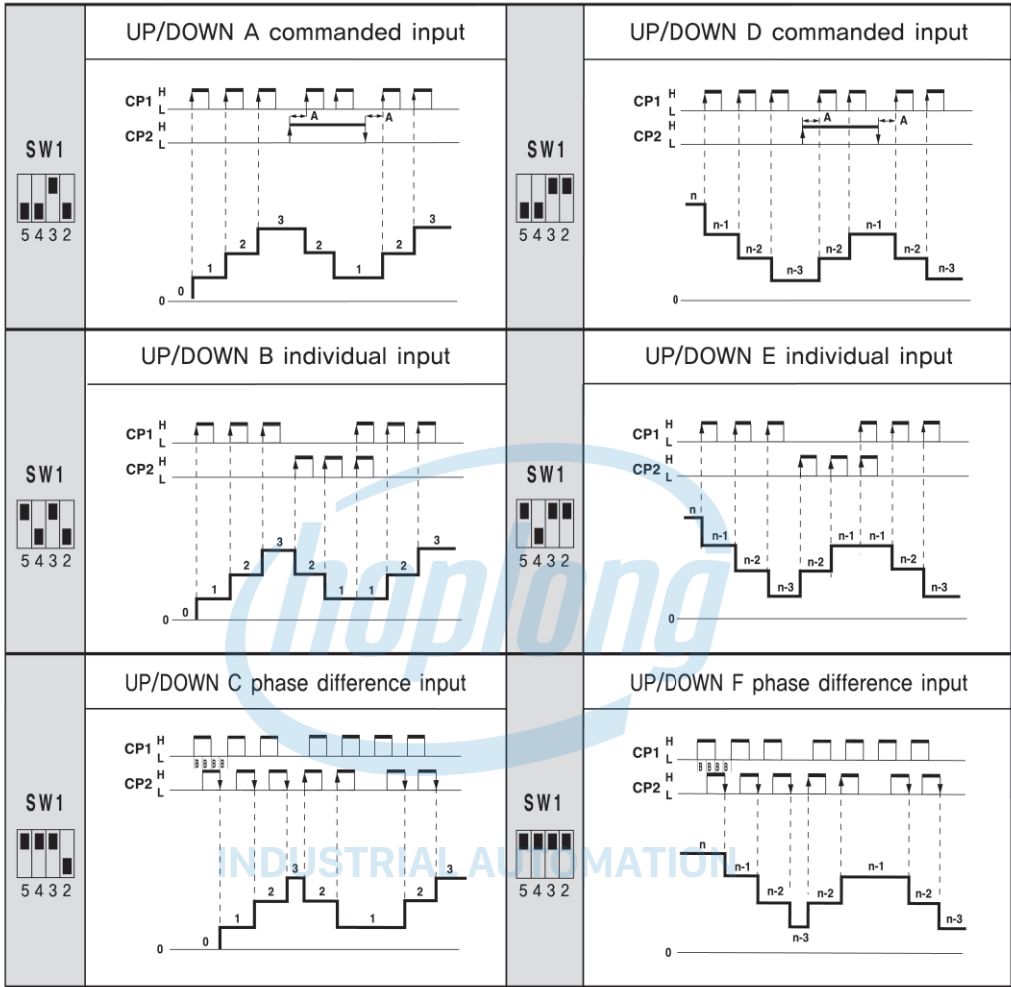

C  
Counter /  
Timer

● Counter output operation

GF4



Self maintaining output



ONE-SHOT output (0.1 ~ 12.5 sec setting)

C

Counter /  
Timer

| Input mode |  | Up mode | Down mode | Operation explanation   |
|------------|--|---------|-----------|---|
| F          | <b>SW 2</b><br>6 5 4<br>Counter /<br>Timer |         |           | <ul style="list-style-type: none"> <li>Disregarding the output occurrence, indicated value will continuously increase or decrease.</li> <li>Until reset signal is applied in, indicated value will continuously increase or decrease and output state will be maintained.</li> </ul>  |
|            |  |         |           | <ul style="list-style-type: none"> <li>Disregarding the output occurrence, indicated value will continuously increase or decrease.</li> <li>Until reset signal is applied in, indicated value will continuously increase or decrease and output state will be maintained.</li> </ul>  |
| N          | <b>SW 2</b><br>6 5 4<br>Counter /<br>Timer |         |           | <ul style="list-style-type: none"> <li>Indicated value will not be displayed once the output is generated.</li> <li>Until Reset signal is applied in, indicated value and output state will be maintained.</li> </ul>   |
|            |  |         |           | <ul style="list-style-type: none"> <li>Indicated value will not be displayed once the output is generated.</li> <li>Until Reset signal is applied in, indicated value and output state will be maintained.</li> </ul>   |
| C          | <b>SW 2</b><br>6 5 4<br>Counter /<br>Timer |         |           | <ul style="list-style-type: none"> <li>Indicated value will be initialized the output is generated.</li> <li>Output state will be maintained for the output set time.</li> <li>Output will be initialized once the output set time is elapsed.</li> <li>Disregarding the set time of output, indicated value will continuously increase or decrease.</li> </ul> |
|            |  |         |           | <ul style="list-style-type: none"> <li>Indicated value will be initialized the output is generated.</li> <li>Output state will be maintained for the output set time.</li> <li>Output will be initialized once the output set time is elapsed.</li> <li>Disregarding the set time of output, indicated value will continuously increase or decrease.</li> </ul> |
| R          | <b>SW 2</b><br>6 5 4<br>Counter /<br>Timer |         |           | <ul style="list-style-type: none"> <li>Indicated value will not be displayed once the output is generated.</li> <li>Output state will be maintained for the output set time</li> <li>Indicated value and output will be initialized once the output set time is elapsed.</li> </ul>   |
|            |  |         |           | <ul style="list-style-type: none"> <li>Indicated value will not be displayed once the output is generated.</li> <li>Output state will be maintained for the output set time</li> <li>Indicated value and output will be initialized once the output set time is elapsed.</li> </ul>   |
| K          | <b>SW 2</b><br>6 5 4<br>Counter /<br>Timer |         |           | <ul style="list-style-type: none"> <li>Disregarding the output occurrence, indicated value will continuously increase or decrease.</li> <li>Output state will be maintained for the output set time.</li> <li>After passing the output set time, output will be initialized without indicated value being changed.</li> </ul>                                   |
|            |  |         |           | <ul style="list-style-type: none"> <li>Disregarding the output occurrence, indicated value will continuously increase or decrease.</li> <li>Output state will be maintained for the output set time.</li> <li>After passing the output set time, output will be initialized without indicated value being changed.</li> </ul>                                   |

|          |  |  |  |   |
|----------|--|--|--|---|
| <p>P</p> | <p>SW2<br/>6 5 4<br/>Counter /<br/>Timer</p> |  |  | <ul style="list-style-type: none"> <li>Indicated value will not be displayed once the output is generated and computed value will be initialized.</li> <li>Output state will be maintained for the output set time and computed value will continuously increase, decrease or stop.</li> <li>Output will be initialized after passing the output set time and the increased or decreased computation value will be displayed.</li> </ul>  |
| <p>Q</p> | <p>SW2<br/>6 5 4<br/>Counter /<br/>Timer</p> |  |  | <ul style="list-style-type: none"> <li>Disregarding the output occurrence, indicated value will either be increased or decreased continuously.</li> <li>Output state will be maintained for the output set time.</li> <li>Indicated value and output will be initialized after passing the output set time.</li> </ul>  |
| <p>S</p> | <p>SW2<br/>6 5 4<br/>Counter</p>             |  |  | <ul style="list-style-type: none"> <li>When using the UP mode and if the indicated value is higher than the set value then output will be generated and if the indicated value is lower than the set value then output state will be maintained.</li> <li>When using the DOWN mode and if the indicated value is lower than 0 then output will be generated and if indicated value is higher than 0 then output will be initialized.</li> <li>If Reset signal is applied in, indicated value and output will be initialized.</li> </ul> |
| <p>A</p> | <p>SW2<br/>6 5 4<br/>Timer</p>               |  |  | <ul style="list-style-type: none"> <li>When using the UP mode and if indicated value is higher than the set value then output will be reversed and indicated value will be initialized.</li> <li>When using the DOWN mode and if indicated value is lower than 0 then output will be reversed and indicated value will be initialized.</li> <li>If Reset signal is applied in, indicated value and output will be initialized.</li> </ul>   |

C

Counter /  
Timer

● Counter output action

**GF7**

(Cautious) Model GF7-P61/P41 operate as the 2nd stage output (OUT2).

(Cautious) Setting the "number 2 of DIP SW2" as "ON" will make 1st stage output(OUT1) to operate as "Flickering(ON-0.5sec, OFF-0.5sec) output", (But number 3 of DIP SW2 must be in OFF state)

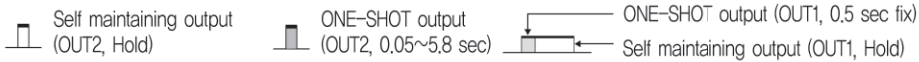

**C**

Counter /  
Timer

| Input mode  |   | Up mode | Down mode | Operation explanation   |
|-------------|---|---------|-----------|---|
| Output mode | F<br>SW2<br>6 5 4<br>Counter /<br>Timer |         |           | <ul style="list-style-type: none"> <li>Disregarding the 2nd stage output occurrence, the indicated value continuously increases or decreases and output state is maintained.</li> <li>Once the Reset signal is supplied in, indicated value and output will be initialized.</li> </ul>  |
|             |   |         |           | <ul style="list-style-type: none"> <li>Indicated value will not be displayed once the 2nd stage output is generated and output state will be maintained.</li> <li>Once Reset signal is supplied in, indicated value and output will be initialized.</li> </ul>  |
|             |   |         |           | <ul style="list-style-type: none"> <li>Indicated value will not be displayed once the 2nd stage output is generated and output state will be maintained.</li> <li>Output state will be maintained for the output set time and output will be initialized once it passes the output set time.</li> <li>1st stage output will be initialized synchronously with the 2nd stage output.</li> <li>Runs above operations repeatedly without supplying in the Reset signal.</li> </ul>           |
|             |   |         |           | <ul style="list-style-type: none"> <li>Indicated value will not be displayed once the 2nd stage output is generated and output state will be maintained.</li> <li>Output state will be maintained for the output set time and indicated value and output will be initialized after passing the output set time.</li> <li>1st stage and 2nd stage output will be initialized at the same time.</li> <li>Runs above operations repeatedly without supplying in the Reset signal.</li> </ul> |

|                 |   |  |  |   |
|-----------------|---|--|--|---|
| <p><b>K</b></p> | <p><b>SW2</b><br/>6 5 4<br/>Counter / Timer</p> |  |  | <ul style="list-style-type: none"> <li>Disregarding the 2nd stage output occurrence, indicated value will continuously increase or decrease.</li> <li>Output state will be maintained for the output set time and once passing the set time, only the output will be initialized. (output state will not be changed)</li> <li>1st stage and 2nd stage output will be initialized at the same time.</li> <li>When Reset signal is supplied in, indicated value and output will be initialized.</li> </ul>  |
| <p><b>P</b></p> | <p><b>SW2</b><br/>6 5 4<br/>Counter / Timer</p> |  |  | <ul style="list-style-type: none"> <li>Indicated value will not be displayed once the 2nd stage output is generated and the computed value will be initialized.</li> <li>Output state will be maintained for the output set time and computed value will continuously increase or decrease without indicated value being changed.</li> <li>Output will be initialized after passing the output set time and the increased/decreased computation value will be displayed.</li> <li>1st stage and 2nd stage output will be initialized at the same time</li> </ul>  |
| <p><b>Q</b></p> | <p><b>SW2</b><br/>6 5 4<br/>Counter / Timer</p> |  |  | <ul style="list-style-type: none"> <li>Disregarding the 2nd stage output occurrence, indicated value will continuously increase or decrease</li> <li>Output state will be maintained for the output set time and indicated value/output will be initialized after passing the output set time</li> <li>1st stage and 2nd stage output will be initialized at the same time.</li> </ul>  |
| <p><b>S</b></p> | <p><b>SW2</b><br/>6 5 4<br/>Counter</p>         |  |  | <ul style="list-style-type: none"> <li>When using the UP mode, 1st stage output will be generated if the indicated value is higher than the 1st stage set value and 1st stage output will be initialized if the indicated value is lower than the 1st stage set value, 2nd stage output will be generated if the indicated value is higher than the 2nd stage set value and will be initialized if lower than the 2nd stage set value.</li> <li>When using the DOWN mode, 1st stage output will be generated if the indicated value is lower than the 1st stage set value and if higher than the 1st stage output then it will initialize the indicated value, 2nd stage output will be generated if the indicated value is lower than 0, and if higher than 0, it will initialize the 2nd stage output.</li> </ul> |
| <p><b>A</b></p> | <p><b>SW2</b><br/>6 5 4<br/>Timer</p>           |  |  | <ul style="list-style-type: none"> <li>when using the UP mode, 2nd stage output will be reversed if the indicated value is higher than the 2nd stage set value and indicated value will be initialized</li> <li>when using the DOWN mode, 2nd stage output will be reversed if the indicated value is lower than 0 and indicated value will be initialized</li> <li>1st stage output will be generated when 2nd stage output is in "OFF" state and the indicated value is higher than the 1st stage set value.</li> </ul>   |

**C**  
Counter / Timer



### Pre-Scale Setting type (Limits with GF7-P)

#### What is Pre-scale function?

- This is the function that computes the number of input signal and converts into the certain numerical value.

#### Example of usage depending on the pre-scale setting

Example) By using the 6 digits counter, users want to display 0.09425 regarding the single input signal by setting the pre-scale value.

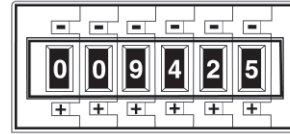

< Front digital switch >

- Set the front side switch "DIP SW1 number 7" to the ON direction in order to select as counter.
- Set the front side switch "DIP SW1 number 8" to the ON direction in order to select as pre-scale mode.
- Set #7 and #8 of deep switch SW2 as ON and press the reset (RST) key in order to set the counter display value and counter set value as 3 decimal points mode.
- Pressing the front SET key will shift the position of decimal points so set the position of decimal point of pre-scale value to the 5th position.
- Set the front digital switch as 0.09425 and press the reset (RST) switch to complete the pre-scale value setting.

### Default specification setting

| Model                         | GF4          | GF7          | Reference        |
|-------------------------------|--------------|--------------|------------------|
| Position of the decimal point | none         | none         | Counter function |
| Counter/timer function        | counter      | counter      | -                |
| Pre-scale setting             | no function  | 1 : 1        | Counter function |
| Power backup memory           | power backup | power backup | -                |
| Computation speed             | 30 cps       | 30 cps       | Counter function |
| Output type                   | ON Delay     | ON Delay     | -                |
| Input action mode             | U-A(R)       | U-A(R)       | -                |
| Output action mode            | F            | F            | -                |
| 2nd stage setting OUT1 output | no function  | Hold         | -                |
| Auto reset time               | 100 ms       | 50 ms        | Counter function |

### Dimension and panel cutout (unit : mm)

#### GF4

#### Dimension

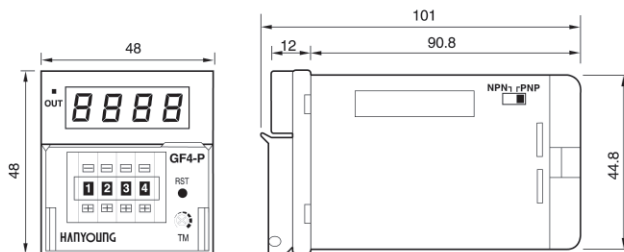

#### Panel cutout

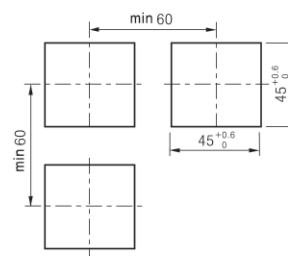

## GF4-P41S

● Dimension

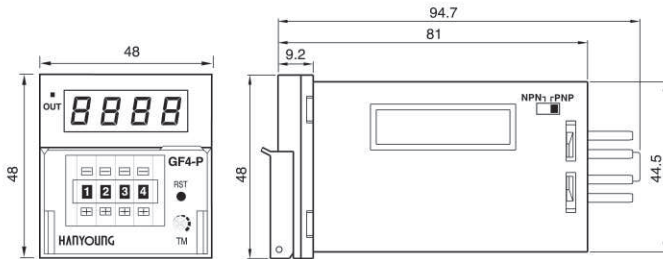

● Panel cutout

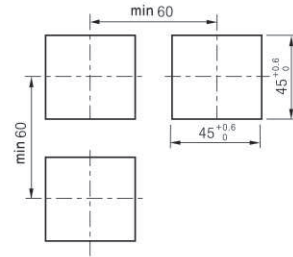

C

Counter /  
Timer

## GF7

● Dimension

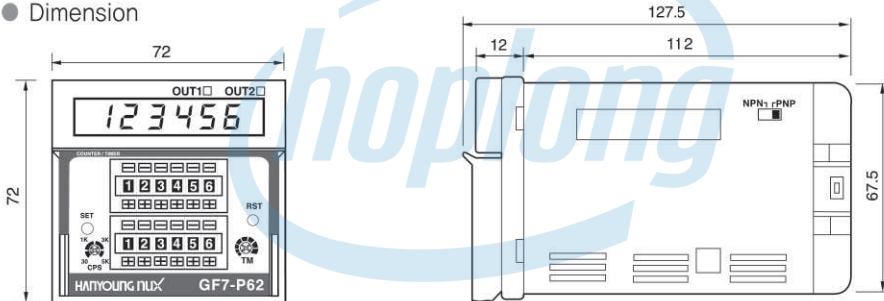

● Panel cutout

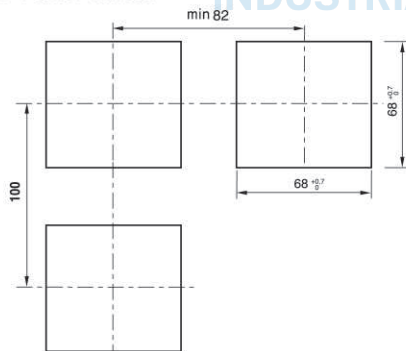

INDUSTRIAL AUTOMATION

### Connection diagram

※ Voltage / Non-voltage selection by the deep switch

#### GF4-P41

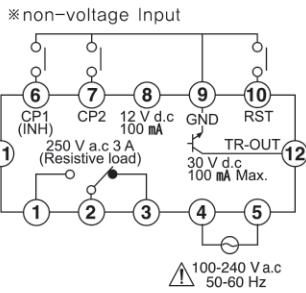

#### GF4-T40

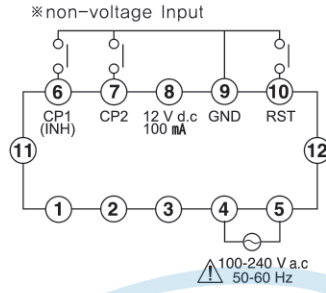

#### GF4-P41S

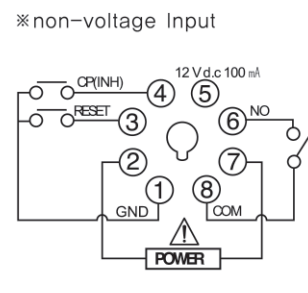

※ Voltage Input

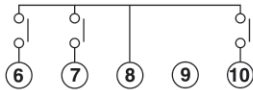

※ Voltage Input

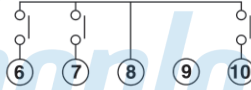

※ Voltage Input

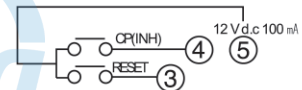

#### GF7-P41, GF7-P61

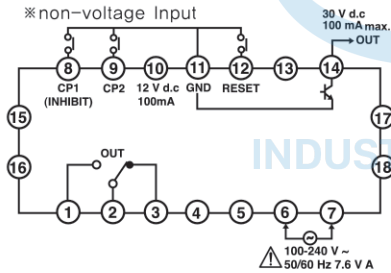

※ Voltage Input

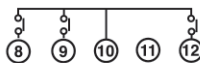

#### GF7-P42, GF7-P62

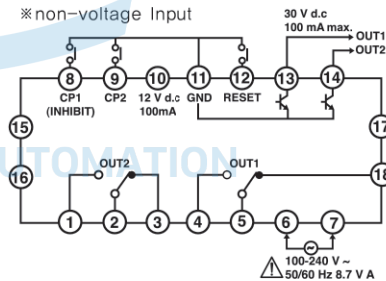

※ Voltage Input

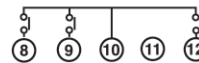

#### GF7-T60

※ non-voltage Input

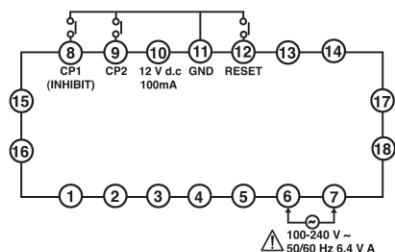

※ Voltage Input

