

FEATURES

- Tend tower light can be installed in any machine as a status indicator by showing the color change of light and audible alarm. Tower light can be customer-made to meet different needs.
- Internal spring suspension can avoid damage to the bulb due to machine's vibration.
- Flexible wiring design: Steady, flashing of alarm are achievable through wiring by end user.
- Both bulb base for Incandescent bulb & LED is BA15S. So it is easy to change bulb type.
- Audio alarm buzzes at 90DB/30cm.

Model Designation

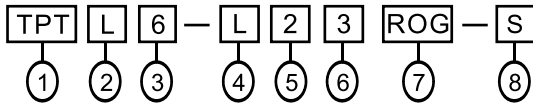

Bulb Model Designation

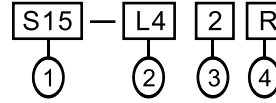

Item	Signal	Description
1. Mounting Method	TPT	Pole Mount
	TPW	Tray Mount
	TPF	Tented Type (Round Tray)
	TPA	Side Hitch Type
	TPS	Pole Stand Type
	TPFQ	Tented Type (Square Tray)
2. Functional	L	Continuous light
	F	Continuous or flashing light
	S	Continuous of flashing light with audible alarm
	B	Audible alarm light
3. Diameter	4	∅40mm (NO TPFL)
	5	∅50mm
	6	∅60mm
	7	∅70mm
4. Bulb	Space	Incandescent
	L	LED
5. Voltage	1	110VAC
	2	220VAC
	7	24VAC/DC
	9	12VAC/DC
6. Section	1~5	1~5
7. Lens	R	Red
	O	Orange
	G	Green
	B	Blue
	W	White
8. Aluminum Tube Length	Space	Standard Length, TPT:288mm, TPF:43mm
	Space	Special Length, TPT:138mm
	S	Special Length, TPF:193mm

Item	Signal	Description
1. Base Type	S15	BA15S Bulb
2. Lens Diameter	I4	∅40mm, 5W Incandescent
	I5	∅50mm, 8W Incandescent
	I6	∅60mm/∅70mm, 10W Incandescent
	L4	∅40mm, LED
	L5	∅50mm/∅60mm/∅70mm, LED
3. Voltage	1	110VAC
	2	220VAC
	7	24VAC/DC
4. Color	9	12VAC/DC
	Space	Incandescent
	R	Red
	O	Orange
	G	Green LED
B	Blue	
W	White	

Mounting Holes

- Tray Mount

TPW □4/TPW □5

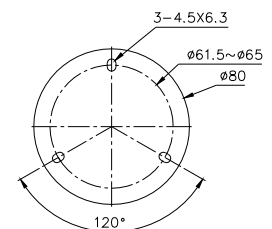
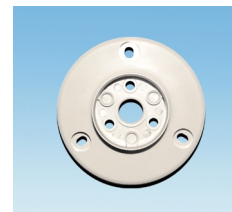

TPW □6

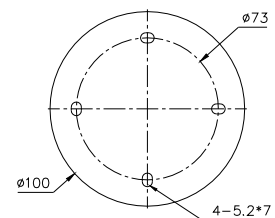
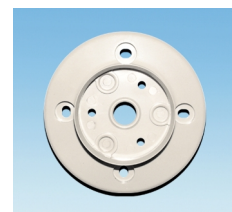

TPW □7

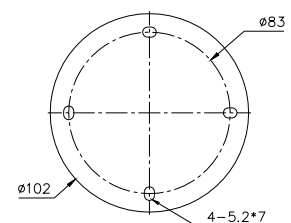
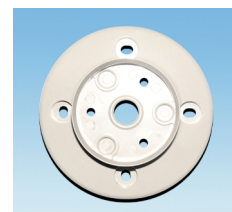

Rated current for Bulbs and Buzzers (Reference Only)

Incandescent	
S15-I49(12VAC/DC)	0.5A
S15-I47(24VAC/DC)	0.25A
S15-I41(110VAC)	0.05A
S15-I42(220VAC)	0.03A
S15-I59(12VAC/DC)	0.7A
S15-I57(24VAC/DC)	0.35A
S15-I51(110VAC)	0.06A
S15-I52(220VAC)	0.03A
S15-I69(12VAC/DC)	0.8A
S15-I67(24VAC/DC)	0.4A
S15-I61(110VAC)	0.08A
S15-I62(220VAC)	0.04A

LED	
S15-L49(12VAC/DC)	0.1A
S15-L47(24VAC/DC)	0.03A
S15-L41(110VAC)	0.02A
S15-L42(220VAC)	0.02A
S15-L59(12VAC/DC)	0.15A
S15-L57(24VAC/DC)	0.04A
S15-L51(110VAC)	0.02A
S15-L52(220VAC)	0.02A
Buzzer	
12V AC/DC	0.08A
24V AC/DC	0.02A
110V AC	0.01A
220V AC	0.01A

■ MOUNTING HOLES

- POLE MOUNTING BRACKET

Used TPTL4

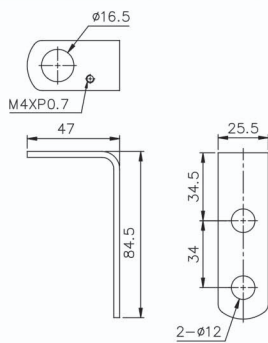

Used TPT□ 6/TPT□ 7

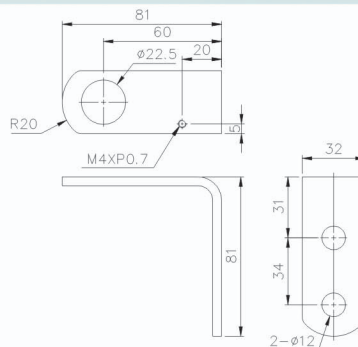

Used TPTF4/TPTS4/TPTB4
TPT□ 5

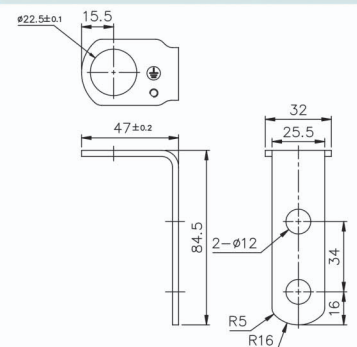

■ MOUNTING HOLES

- POLE MOUNTING BRACKET(OPTIONAL)

TPTL-S
Used TPTL4

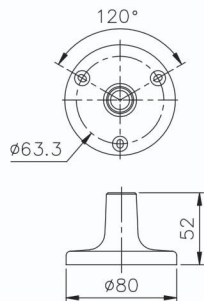

TPTL6-S
Used TPTS4/TPTF4/TPTB4
TPT□ 5/TPT□ 6/TPT□ 7

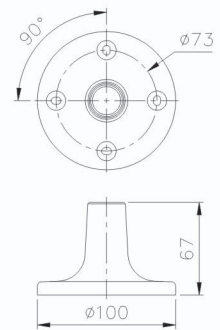

- FOLDABLE MOUNTING BRACKET(OPTIONAL)

TPTL6-F
Used TPTS4/TPTF4/TPTB4
TPT□ 5/TPT□ 6/TPT□ 7

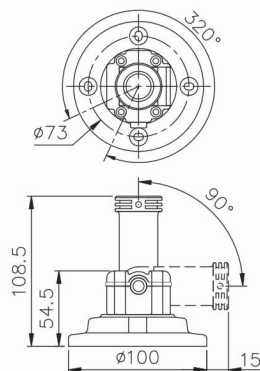
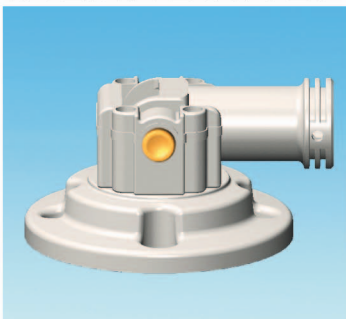

- SIDE MOUNTING BRACKET(OPTIONAL)

TPTL6-A
Used TPT□ 4
TPT□ 5/TPT□ 6/TPT□ 7

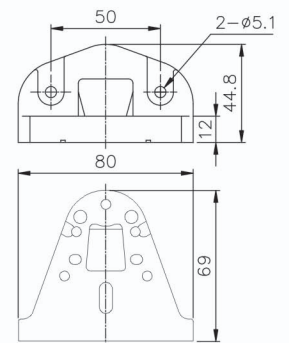
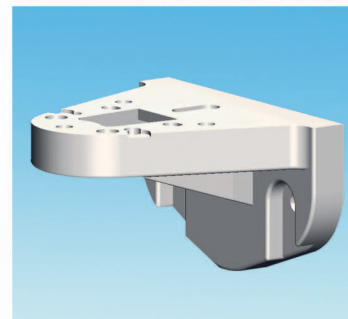

■ TPTL4/TPAL4



■ TP□F4/TP□S4/TP□B4



■ TPWL4



■ TPWF4/TPWS4/TPWB4



■ TPTL5/TPAL5/TPFL5



■ TP□F5/TP□S5/TP□B5



■ TPWL5



■ TPWF5/TPWS5/TPWB5



■ TPTL6/TPAL6/TPFL6



■ TP□F6/TP□S6/TP□B6



■ TPWL6



■ TPWF6/TPWS6/TPWB6



■ TPTL7/TPAL7/TPTF7



■ TP□F7/TP□S7/TP□B7





■ TPWL7



■ TPWF7/TPWS7/TPWB7

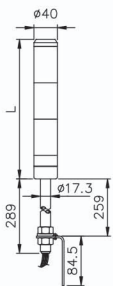
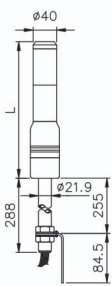
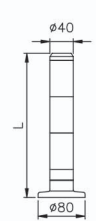
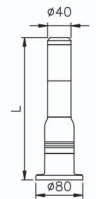
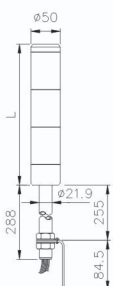
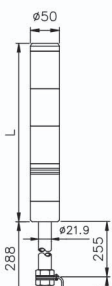

DIMENSIONS

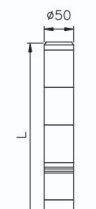
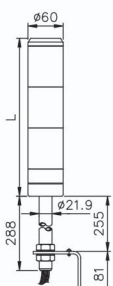
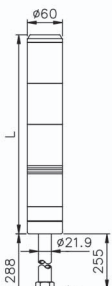
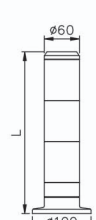
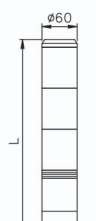
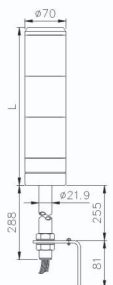
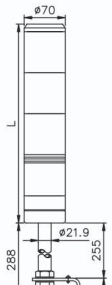
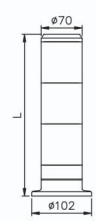
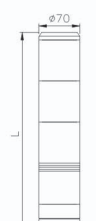
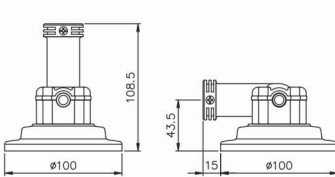
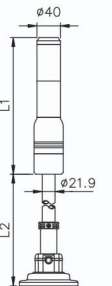
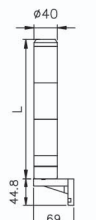
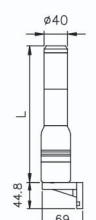
 <p>• TPTL4:</p> <table border="1"> <thead> <tr> <th>SECTION</th> <th>L</th> </tr> </thead> <tbody> <tr><td>1</td><td>114</td></tr> <tr><td>2</td><td>176</td></tr> <tr><td>3</td><td>238</td></tr> <tr><td>4</td><td>300</td></tr> <tr><td>5</td><td>362</td></tr> </tbody> </table>	SECTION	L	1	114	2	176	3	238	4	300	5	362	 <p>• TPTF4/TPTS4 TPTB4:</p> <table border="1"> <thead> <tr> <th>SECTION</th> <th>L</th> </tr> </thead> <tbody> <tr><td>1</td><td>171</td></tr> <tr><td>2</td><td>233</td></tr> <tr><td>3</td><td>295</td></tr> <tr><td>4</td><td>357</td></tr> <tr><td>5</td><td>419</td></tr> </tbody> </table>	SECTION	L	1	171	2	233	3	295	4	357	5	419	 <p>• TPWL4:</p> <table border="1"> <thead> <tr> <th>SECTION</th> <th>L</th> </tr> </thead> <tbody> <tr><td>1</td><td>122</td></tr> <tr><td>2</td><td>184</td></tr> <tr><td>3</td><td>246</td></tr> <tr><td>4</td><td>308</td></tr> <tr><td>5</td><td>370</td></tr> </tbody> </table>	SECTION	L	1	122	2	184	3	246	4	308	5	370	 <p>• TPWF4/TPWS4 TPWB4:</p> <table border="1"> <thead> <tr> <th>SECTION</th> <th>L</th> </tr> </thead> <tbody> <tr><td>1</td><td>181</td></tr> <tr><td>2</td><td>243</td></tr> <tr><td>3</td><td>305</td></tr> <tr><td>4</td><td>367</td></tr> <tr><td>5</td><td>429</td></tr> </tbody> </table>	SECTION	L	1	181	2	243	3	305	4	367	5	429
SECTION	L																																																		
1	114																																																		
2	176																																																		
3	238																																																		
4	300																																																		
5	362																																																		
SECTION	L																																																		
1	171																																																		
2	233																																																		
3	295																																																		
4	357																																																		
5	419																																																		
SECTION	L																																																		
1	122																																																		
2	184																																																		
3	246																																																		
4	308																																																		
5	370																																																		
SECTION	L																																																		
1	181																																																		
2	243																																																		
3	305																																																		
4	367																																																		
5	429																																																		
 <p>• TPTL5:</p> <table border="1"> <thead> <tr> <th>SECTION</th> <th>L</th> </tr> </thead> <tbody> <tr><td>1</td><td>112</td></tr> <tr><td>2</td><td>176</td></tr> <tr><td>3</td><td>240</td></tr> <tr><td>4</td><td>304</td></tr> <tr><td>5</td><td>368</td></tr> </tbody> </table>	SECTION	L	1	112	2	176	3	240	4	304	5	368	 <p>• TPTF5/TPTS5 TPTB5:</p> <table border="1"> <thead> <tr> <th>SECTION</th> <th>L</th> </tr> </thead> <tbody> <tr><td>1</td><td>176</td></tr> <tr><td>2</td><td>240</td></tr> <tr><td>3</td><td>304</td></tr> <tr><td>4</td><td>368</td></tr> <tr><td>5</td><td>432</td></tr> </tbody> </table>	SECTION	L	1	176	2	240	3	304	4	368	5	432	 <p>• TPWL5:</p> <table border="1"> <thead> <tr> <th>SECTION</th> <th>L</th> </tr> </thead> <tbody> <tr><td>1</td><td>122</td></tr> <tr><td>2</td><td>186</td></tr> <tr><td>3</td><td>250</td></tr> <tr><td>4</td><td>314</td></tr> <tr><td>5</td><td>378</td></tr> </tbody> </table>	SECTION	L	1	122	2	186	3	250	4	314	5	378	 <p>• TPWF5/TPWS5 TPWB5:</p> <table border="1"> <thead> <tr> <th>SECTION</th> <th>L</th> </tr> </thead> <tbody> <tr><td>1</td><td>186</td></tr> <tr><td>2</td><td>250</td></tr> <tr><td>3</td><td>314</td></tr> <tr><td>4</td><td>378</td></tr> <tr><td>5</td><td>442</td></tr> </tbody> </table>	SECTION	L	1	186	2	250	3	314	4	378	5	442
SECTION	L																																																		
1	112																																																		
2	176																																																		
3	240																																																		
4	304																																																		
5	368																																																		
SECTION	L																																																		
1	176																																																		
2	240																																																		
3	304																																																		
4	368																																																		
5	432																																																		
SECTION	L																																																		
1	122																																																		
2	186																																																		
3	250																																																		
4	314																																																		
5	378																																																		
SECTION	L																																																		
1	186																																																		
2	250																																																		
3	314																																																		
4	378																																																		
5	442																																																		
 <p>• TPTL6:</p> <table border="1"> <thead> <tr> <th>SECTION</th> <th>L</th> </tr> </thead> <tbody> <tr><td>1</td><td>130</td></tr> <tr><td>2</td><td>200</td></tr> <tr><td>3</td><td>270</td></tr> <tr><td>4</td><td>340</td></tr> <tr><td>5</td><td>410</td></tr> </tbody> </table>	SECTION	L	1	130	2	200	3	270	4	340	5	410	 <p>• TPTF6/TPTS6 TPTB6:</p> <table border="1"> <thead> <tr> <th>SECTION</th> <th>L</th> </tr> </thead> <tbody> <tr><td>1</td><td>200</td></tr> <tr><td>2</td><td>270</td></tr> <tr><td>3</td><td>340</td></tr> <tr><td>4</td><td>410</td></tr> <tr><td>5</td><td>480</td></tr> </tbody> </table>	SECTION	L	1	200	2	270	3	340	4	410	5	480	 <p>• TPWL6:</p> <table border="1"> <thead> <tr> <th>SECTION</th> <th>L</th> </tr> </thead> <tbody> <tr><td>1</td><td>136</td></tr> <tr><td>2</td><td>206</td></tr> <tr><td>3</td><td>276</td></tr> <tr><td>4</td><td>346</td></tr> <tr><td>5</td><td>416</td></tr> </tbody> </table>	SECTION	L	1	136	2	206	3	276	4	346	5	416	 <p>• TPWF6/TPWS6 TPWB6:</p> <table border="1"> <thead> <tr> <th>SECTION</th> <th>L</th> </tr> </thead> <tbody> <tr><td>1</td><td>206</td></tr> <tr><td>2</td><td>276</td></tr> <tr><td>3</td><td>346</td></tr> <tr><td>4</td><td>416</td></tr> <tr><td>5</td><td>486</td></tr> </tbody> </table>	SECTION	L	1	206	2	276	3	346	4	416	5	486
SECTION	L																																																		
1	130																																																		
2	200																																																		
3	270																																																		
4	340																																																		
5	410																																																		
SECTION	L																																																		
1	200																																																		
2	270																																																		
3	340																																																		
4	410																																																		
5	480																																																		
SECTION	L																																																		
1	136																																																		
2	206																																																		
3	276																																																		
4	346																																																		
5	416																																																		
SECTION	L																																																		
1	206																																																		
2	276																																																		
3	346																																																		
4	416																																																		
5	486																																																		
 <p>• TPTL7:</p> <table border="1"> <thead> <tr> <th>SECTION</th> <th>L</th> </tr> </thead> <tbody> <tr><td>1</td><td>130</td></tr> <tr><td>2</td><td>200</td></tr> <tr><td>3</td><td>270</td></tr> <tr><td>4</td><td>340</td></tr> <tr><td>5</td><td>410</td></tr> </tbody> </table>	SECTION	L	1	130	2	200	3	270	4	340	5	410	 <p>• TPTF7/TPTS7 TPTB7:</p> <table border="1"> <thead> <tr> <th>SECTION</th> <th>L</th> </tr> </thead> <tbody> <tr><td>1</td><td>200</td></tr> <tr><td>2</td><td>270</td></tr> <tr><td>3</td><td>340</td></tr> <tr><td>4</td><td>410</td></tr> <tr><td>5</td><td>480</td></tr> </tbody> </table>	SECTION	L	1	200	2	270	3	340	4	410	5	480	 <p>• TPWL7:</p> <table border="1"> <thead> <tr> <th>SECTION</th> <th>L</th> </tr> </thead> <tbody> <tr><td>1</td><td>136</td></tr> <tr><td>2</td><td>206</td></tr> <tr><td>3</td><td>276</td></tr> <tr><td>4</td><td>346</td></tr> <tr><td>5</td><td>416</td></tr> </tbody> </table>	SECTION	L	1	136	2	206	3	276	4	346	5	416	 <p>• TPWF7/TPWS7 TPWB7:</p> <table border="1"> <thead> <tr> <th>SECTION</th> <th>L</th> </tr> </thead> <tbody> <tr><td>1</td><td>206</td></tr> <tr><td>2</td><td>276</td></tr> <tr><td>3</td><td>346</td></tr> <tr><td>4</td><td>416</td></tr> <tr><td>5</td><td>486</td></tr> </tbody> </table>	SECTION	L	1	206	2	276	3	346	4	416	5	486
SECTION	L																																																		
1	130																																																		
2	200																																																		
3	270																																																		
4	340																																																		
5	410																																																		
SECTION	L																																																		
1	200																																																		
2	270																																																		
3	340																																																		
4	410																																																		
5	480																																																		
SECTION	L																																																		
1	136																																																		
2	206																																																		
3	276																																																		
4	346																																																		
5	416																																																		
SECTION	L																																																		
1	206																																																		
2	276																																																		
3	346																																																		
4	416																																																		
5	486																																																		
<p>• TPTL6-F</p> 	 <p>• TPTF4/TPFS4 TPTB4:</p> <table border="1"> <thead> <tr> <th>SECTION</th> <th>L1</th> <th>L2</th> </tr> </thead> <tbody> <tr><td>1</td><td>171</td><td>Short151</td></tr> <tr><td>2</td><td>233</td><td>Long 301</td></tr> <tr><td>3</td><td>295</td><td></td></tr> <tr><td>4</td><td>357</td><td></td></tr> <tr><td>5</td><td>419</td><td></td></tr> </tbody> </table>	SECTION	L1	L2	1	171	Short151	2	233	Long 301	3	295		4	357		5	419		 <p>• TPAL4:</p> <table border="1"> <thead> <tr> <th>SECTION</th> <th>L</th> </tr> </thead> <tbody> <tr><td>1</td><td>114</td></tr> <tr><td>2</td><td>176</td></tr> <tr><td>3</td><td>238</td></tr> <tr><td>4</td><td>300</td></tr> <tr><td>5</td><td>362</td></tr> </tbody> </table>	SECTION	L	1	114	2	176	3	238	4	300	5	362	 <p>• TPAF4/TPAS4 TPAB4:</p> <table border="1"> <thead> <tr> <th>SECTION</th> <th>L</th> </tr> </thead> <tbody> <tr><td>1</td><td>171</td></tr> <tr><td>2</td><td>233</td></tr> <tr><td>3</td><td>295</td></tr> <tr><td>4</td><td>357</td></tr> <tr><td>5</td><td>419</td></tr> </tbody> </table>	SECTION	L	1	171	2	233	3	295	4	357	5	419						
SECTION	L1	L2																																																	
1	171	Short151																																																	
2	233	Long 301																																																	
3	295																																																		
4	357																																																		
5	419																																																		
SECTION	L																																																		
1	114																																																		
2	176																																																		
3	238																																																		
4	300																																																		
5	362																																																		
SECTION	L																																																		
1	171																																																		
2	233																																																		
3	295																																																		
4	357																																																		
5	419																																																		

● TPFL5:

SECTION	L1	L2
1	112	Short 151
2	176	Long 301
3	240	
4	304	
5	368	

● TPFF5/TPFS5
TPFB5:

SECTION	L1	L2
1	176	Short 151
2	240	Long 301
3	304	
4	368	
5	432	

● TPAL5:

SECTION	L
1	112
2	176
3	240
4	304
5	368

● TPAF5/TPAS5
TPAB5:

SECTION	L
1	176
2	240
3	304
4	368
5	432

● TPFL6:

SECTION	L1	L2
1	130	Short 151
2	200	Long 301
3	270	
4	340	
5	410	

● TPFF6/TPFS6
TPFB6:

SECTION	L1	L2
1	200	Short 151
2	270	Long 301
3	340	
4	410	
5	480	

● TPAL6:

SECTION	L
1	130
2	200
3	270
4	340
5	410

● TPAF6/TPAS6
TPAB6:

SECTION	L
1	200
2	270
3	340
4	410
5	480

● TPFL7:

SECTION	L1	L2
1	130	Short 151
2	200	Long 301
3	270	
4	340	
5	410	

● TPFF7/TPFS7
TPFB7:

SECTION	L1	L2
1	200	Short 151
2	270	Long 301
3	340	
4	410	
5	480	

● TPAL7:

SECTION	L
1	130
2	200
3	270
4	340
5	410

● TPAF7/TPAS7
TPAB7:

SECTION	L
1	200
2	270
3	340
4	410
5	480

WIRING DIAGRAM

